

Typical Frame Specification

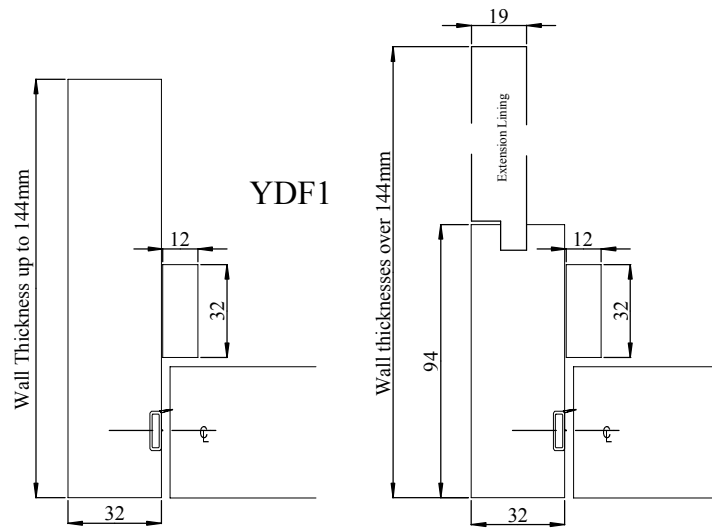

YDF1

LININGS & STOPS : (Stops supplied in loose lengths)
Lining - Thickness 32mm.
Timber Grade - Equal to or exceeding class J30 as specified in BS EN 942: 2007
Species - As noted in Y.D. schedule. Density to comply with BM Trada fire certification.

EXTENSION LININGS : (Supplied in loose lengths)
Paint Grade - MDF, rebated to suit lining groove, finished as lining.
Hardwood for Clear Finish - Species & finish as lining.

ARCHITRAVES : (Supplied in loose lengths)
Section - As Y.D. standard patterns as noted in Y.D. schedule
Paint grade - MDF.
Hardwood for Clear Finish - Species as linings.

DECORATIVE UNDER COATS : (Finishing coats to be site applied following installation).
Paint Grade - Linings, stops & architraves - One coat of white water based primer
Clear Finish - Linings, stops & architraves - One coat of clear water based sealer.

PERIMETER SEALS : (Supplied in loose lengths).
Acoustic - NOR710 - Colour Black.
Fire - Pyroplex - To comply with BM Trada certification. Colour - White for primed linings, Brown for clear finish linings.

DELIVERED
Assembled & braced or knock down (un assembled) as noted in schedule.

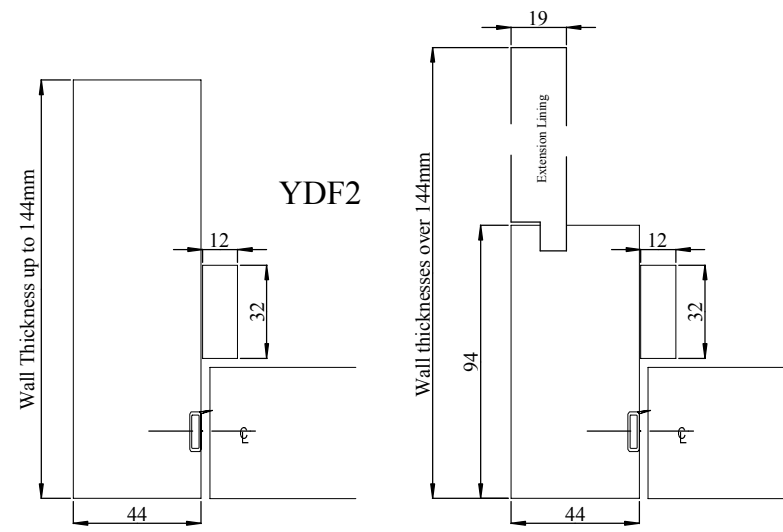

YDF2

LININGS & STOPS : (Stops supplied in loose lengths)
Lining - Thickness 44mm
Timber Grade - Equal to or exceeding class J30 as specified in BS EN 942: 2007
Species - As noted in Y.D. schedule. Density to comply with BM Trada fire certification.

EXTENSION LININGS : (Supplied in loose lengths)
Paint Grade - MDF, rebated to suit lining groove, finished as lining.
Hardwood for Clear Finish - Species & finish as lining.

ARCHITRAVES : (Supplied in loose lengths)
Section - As Y.D. standard patterns as noted in Y.D. schedule
Paint grade - MDF.
Hardwood for Clear Finish - Species as linings.

DECORATIVE UNDER COATS : (Finishing coats to be site applied following installation).
Paint Grade - Linings, stops & architraves - One coat of white water based primer
Clear Finish - Linings, stops & architraves - One coat of clear water based sealer.

PERIMETER SEALS : (Supplied in loose lengths).
Acoustic - NOR710 - Colour Black.
Fire - Pyroplex - To comply with BM Trada certification. Colour - White for primed linings, Brown for clear finish linings.

DELIVERED
Assembled & braced or knock down (un assembled) as noted in schedule.

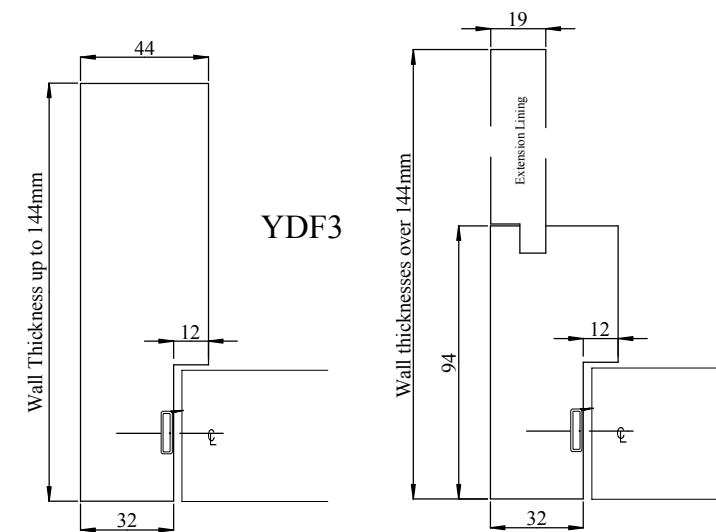

YDF3

REBATED LININGS :
Lining - Thickness 44mm c/w 12mm integral rebated stop as above.
Timber Grade - Equal to or exceeding class J30 as specified in BS EN 942: 2007
Species - As noted in Y.D. schedule. Density to comply with BM Trada fire certification.

EXTENSION LININGS : (Supplied in loose lengths)
Paint Grade - MDF, rebated to suit lining groove, finished as lining.
Hardwood for Clear Finish - Species & finish as lining.

ARCHITRAVES : (Supplied in loose lengths)
Section - As Y.D. standard patterns as noted in Y.D. schedule
Paint grade - MDF.
Hardwood for Clear Finish - Species as linings.

DECORATIVE UNDER COATS : (Finishing coats to be site applied following installation).
Paint Grade - Linings, stops & architraves - One coat of white water based primer
Clear Finish - Linings, stops & architraves - One coat of clear water based sealer.

PERIMETER SEALS : (Supplied in loose lengths).
Acoustic - NOR710 - Colour Black.
Fire - Pyroplex - To comply with BM Trada certification. Colour - White for primed linings, Brown for clear finish linings.

DELIVERED
Assembled & braced or knock down (un assembled) as noted in schedule.

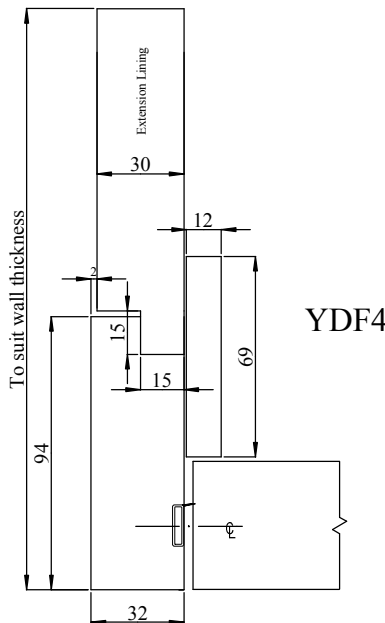

YDF4

SPLIT LININGS & STOPS : (Stops supplied in loose lengths)
Lining - 32 x 94mm rebated as above.
Timber Grade - Equal to or exceeding class J30 as specified in BS EN 942: 2007
Species - As noted in Y.D. schedule. Density to comply with BM Trada fire certification.

EXTENSION LINING : 30mm (Supplied in loose lengths)
Paint Grade - MDF, rebated to suit lining rebate, finished as lining.
Hardwood for Clear Finish - Species & finish as lining.

ARCHITRAVES : (Supplied in loose lengths)
Section - As Y.D. standard patterns as noted in Y.D. schedule
Paint grade - MDF.
Hardwood for Clear Finish - Species as linings.

DECORATIVE UNDER COATS : (Finishing coats to be site applied following installation).
Paint Grade - Linings, stops & architraves - One coat of white water based primer
Clear Finish - Linings, stops & architraves - One coat of clear water based sealer.

PERIMETER SEALS : (Supplied in loose lengths).
Acoustic - NOR710 - Colour Black.
Fire - Pyroplex - To comply with BM Trada certification. Colour - White for primed linings, Brown for clear finish linings.

DELIVERED
Assembled & braced or knock down (un assembled) as noted in schedule.

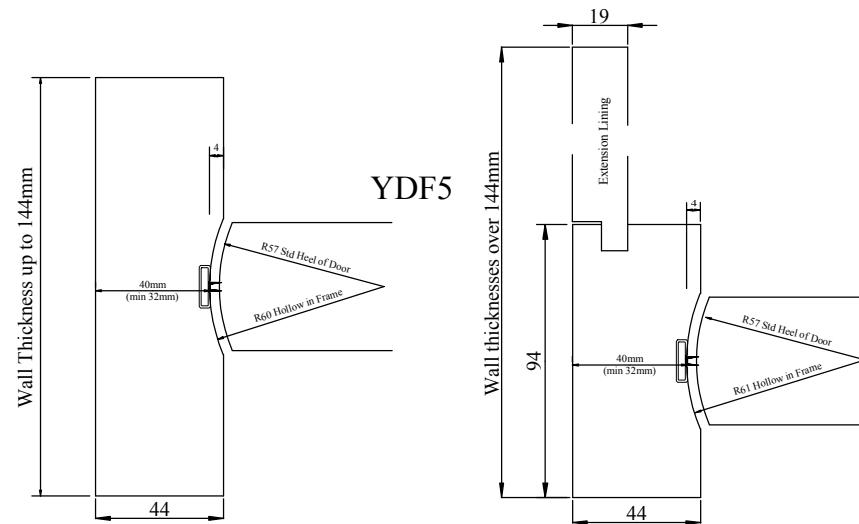

YDF5

DOUBLE ACTION LININGS :
Jamb - Thickness 44mm, hanging jambs scolloped as above
Head - Thickness 44mm, square section.
Timber Grade - Equal to or exceeding class J30 as specified in BS EN 942: 2007
Species - As noted in Y.D. schedule. Density to comply with BM Trada fire certification.

EXTENSION LININGS : (Supplied in loose lengths)
Paint Grade - MDF, rebated to suit lining groove, finished as lining.
Hardwood for Clear Finish - Species & finish as lining.

ARCHITRAVES : (Supplied in loose lengths)
Section - As Y.D. standard patterns as noted in Y.D. schedule
Paint grade - MDF.
Hardwood for Clear Finish - Species as linings.

DECORATIVE UNDER COATS : (Finishing coats to be site applied following installation).
Paint Grade - Linings, stops & architraves - One coat of white water based primer
Clear Finish - Linings, stops & architraves - One coat of clear water based sealer.

PERIMETER SEALS : (Supplied in loose lengths).
Acoustic - Max 32dB (single doors). Details on request.
Fire - Pyroplex - To comply with BM Trada certification. Colour - White for primed linings, Brown for clear finish linings.

DELIVERED
Assembled & braced or knock down (un assembled) as noted in schedule.

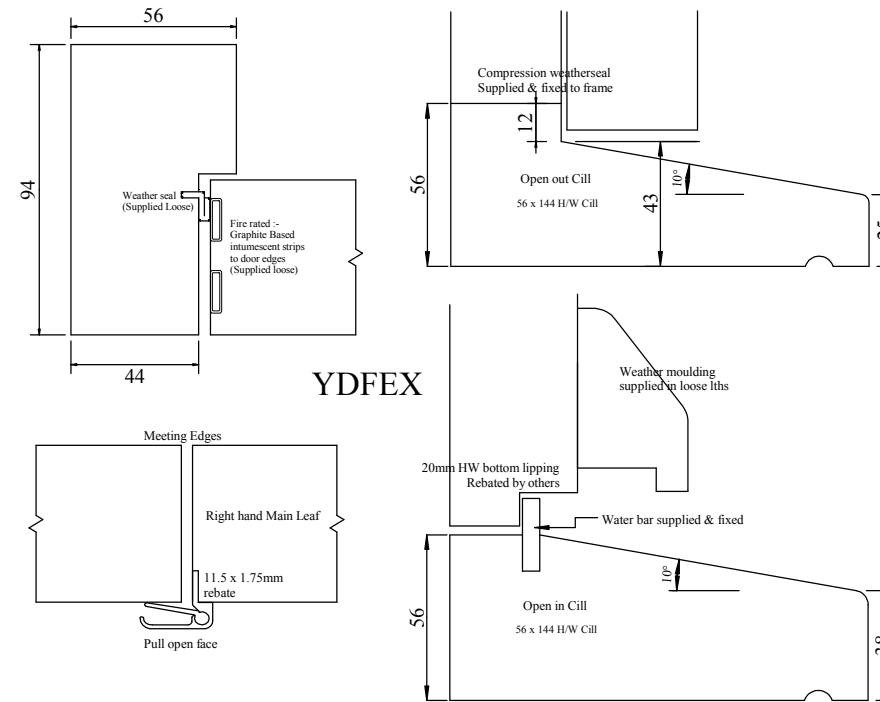

YDFEX

EXTERNAL REBATED LININGS :
Lining - Thickness 56mm c/w 12mm integral rebated stop as above.
Timber Grade - Equal to or exceeding class J30 as specified in BS EN 942: 2007
Species - Either preservative treated softwood or durable hardwood. As noted in Y.D. schedule.

Door meeting edges - Square with rebate to accommodate NOR510 Alu weather strip. Strip supplied loose.

DECORATIVE UNDER COATS : (Finishing coats to be site applied following installation).
Paint Grade - Linings, stops & architraves - One coat of white water based primer
Clear Finish - Linings, stops & architraves - One coat of clear water based sealer.

PERIMETER SEALS : (Supplied in loose lengths).
Acoustic - NOR710 - Colour Black.
Fire - Pyroplex - To comply with BM Trada certification. Colour - White for primed linings, Brown for clear finish linings.
Weather - Supplied loose for fixing following final decoration coats.

DELIVERED - Assembled

Architraves

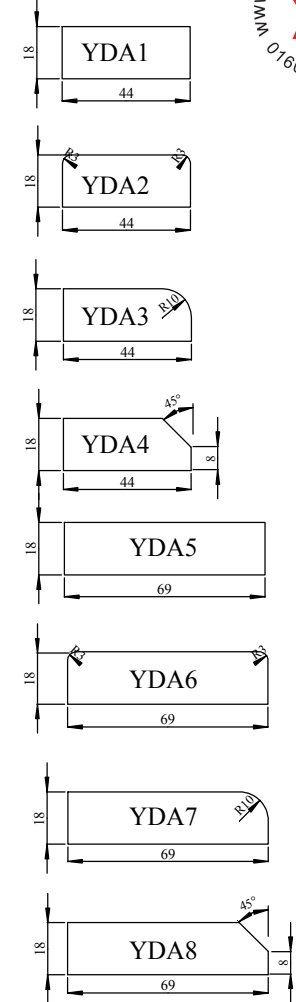

Skirting

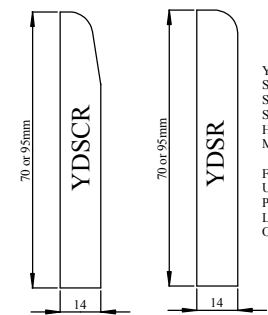

YOUNGS DOORS SKIRTING
Species available :
Softwood (58's)
Softwood - Unsorted Redwood
Hardwood - Various species.
MDF

Finishes available :
Un decorated
Primed
Lacquered
Other profiles available on request

Head / Jamb Joints

